

# **ChemResist**

ROTATIONAL-LINING

Premium linings for all  
industrial fields

**Rudolf Gutbrod GmbH**

## MANY YEARS OF EXPERIENCE WITH ChemResist

Rudolf Gutbrod GmbH set standards early on as one of the leading fluoropolymer processors in Europe. Customer orientation is given a major priority at Rudolf Gutbrod GmbH. Many years of practical experience, consistent development of new technologies and a cooperation marked by flexibility, open-mindedness and commitment are also just as important for Rudolf Gutbrod GmbH.

Rudolf Gutbrod GmbH is a pioneer in lining technology with its innovative and economic product "ChemResist Rotational Sinter Lining". Quite often

the conventional lining and coating technologies available in the market do not fulfil the many requirements placed on them. ChemResist puts a new emphasis in this case using a process and computer-controlled lining technology according to the rotational sinter lining process. This procedure creates a seamless lining with virtually uniform coating thickness.

High-quality partially and fully fluorinated materials, such as ETFE und PFA, and the high performance polymers PE, PP and PA, are used by ChemResist.

PERFECT SOLUTION FOR  
SINTER LINING PROJECTS

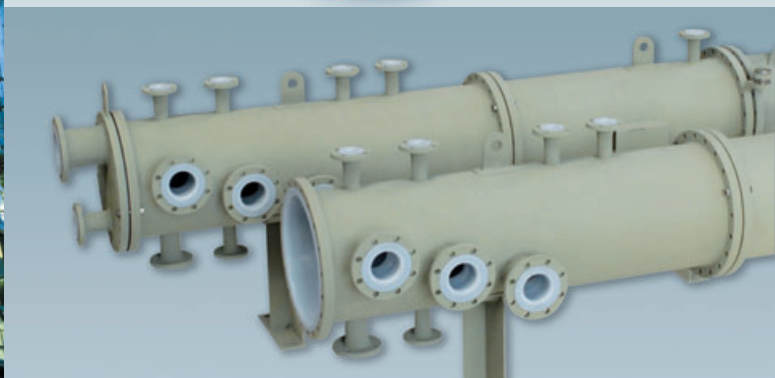

The interplay between our know-how, modern facilities and equipment and our motivated and qualified employees creates a perfect quality, which satisfies the highest requirements.



ETFE and PE are also available as electrically conducting versions. ChemResist can also supply with FDA-conform certification upon request. This also applies to electrically conductive specifications.

Partly and fully fluorinated polymers offer universal and permanent resistance to acids, alkalis, solvents and chlorides. ChemResist possesses an extremely smooth and anti-adhesive surface and thus prevents bacterial adherence or growth.

In the manufacture of highly pure products (chip industry, high purity grade chemicals) ChemResist

prevents impaired quality from foreign substances or dissolved metallic ions.

If special parts are to be lined, ChemResist possesses distinct advantages both from an economic as well as a qualitative point of view. The process can be adapted flexibly to the circumstances or requirements (preparation of tooling is not required). Even rigid construction specifications can be solved economically with ChemResist.

Mechanical preliminary work, as well as the use of adhesives, can be avoided. Chemical resistance



and high temperature resilience remain unaffected. The permanent and homogeneous lamination to the substrate means new and interesting perspectives in use under vacuum.

ChemResist opens up new and versatile options for surface protection in almost all areas of industry to the user and the planning engineer.

## ROTATIONAL SINTER LINING APPLICATIONS HAVE BEEN USED SUCCESSFULLY FOR 25 YEARS

### Chemical and pharmaceutical industry

Reactors and column plates, pipe-work, reduction adapters, vessels, tanks, valves, cylinders, filters, pump casings, vibration filters, centrifuge casings, filters, galvanizing baths, etc.

### Foodstuffs industry

Hoppers, pipe-work, vessels, etc.

### Semi-conductor technology

Pure water tanks, vessels for highly purified chemicals, exhaust air ventilation systems, solar energy, semi-conductor technology, etc.

PERFECT SOLUTION FOR SINTER LINING PROJECTS

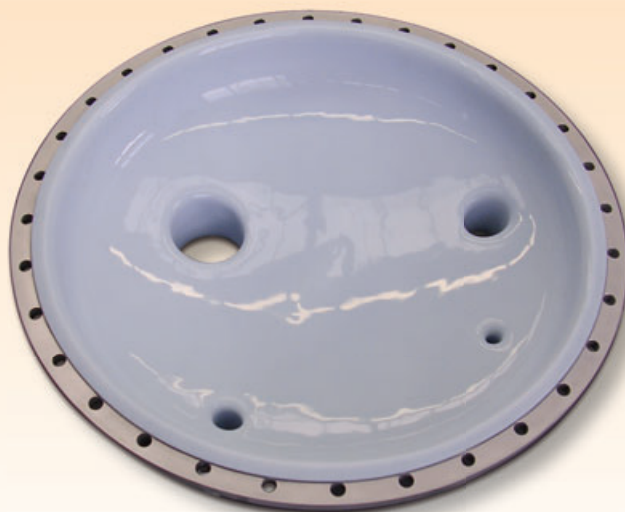

# HOW DOES ROTATIONAL SINTER LINING WORK?

Rotational sinter lining is carried out by filling ultra-pure thermoplastic granulate (with good flowing properties) into the hollow body, pipe or vessel to be lined. The object holder is heated and turned bi-axially so that a uniform layer thickness of molten granulate is applied seamlessly to the inner surface of the component.

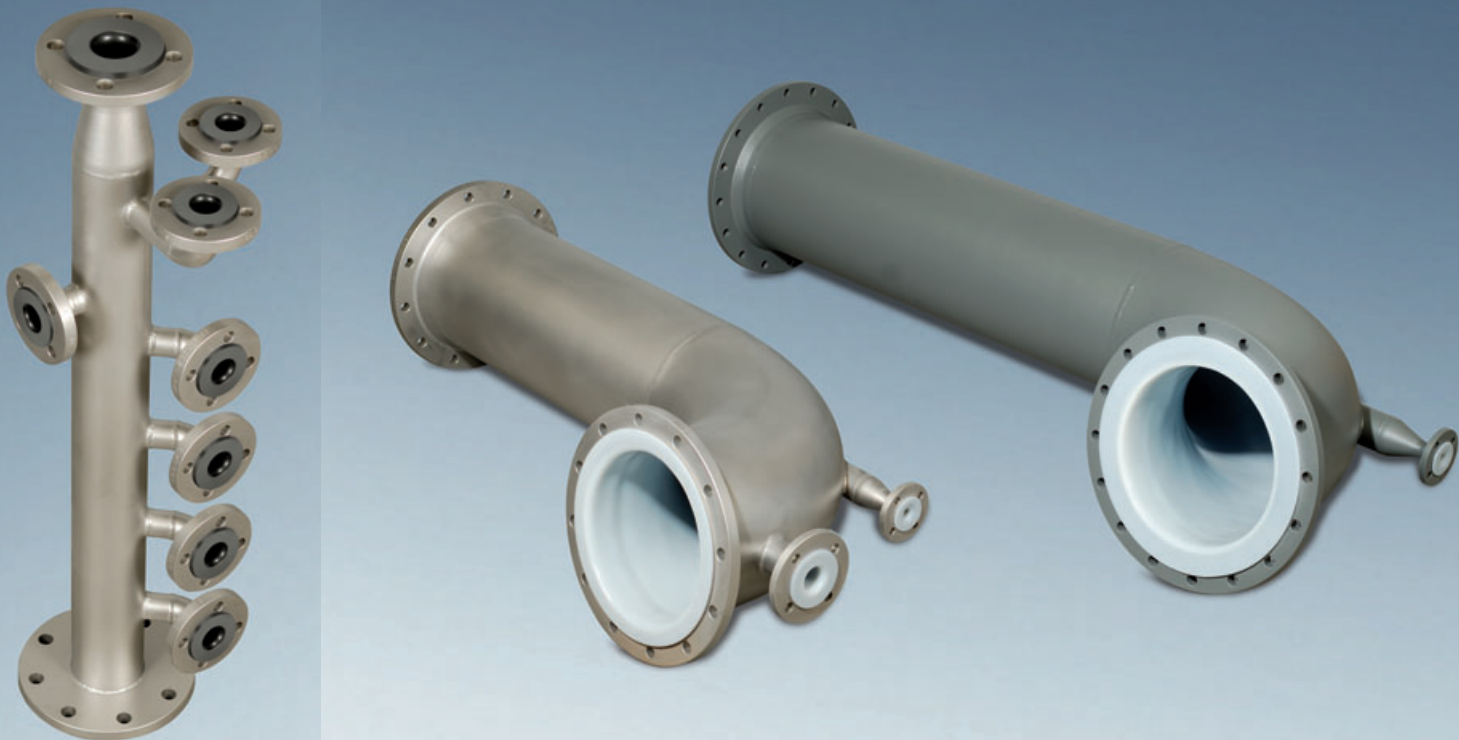
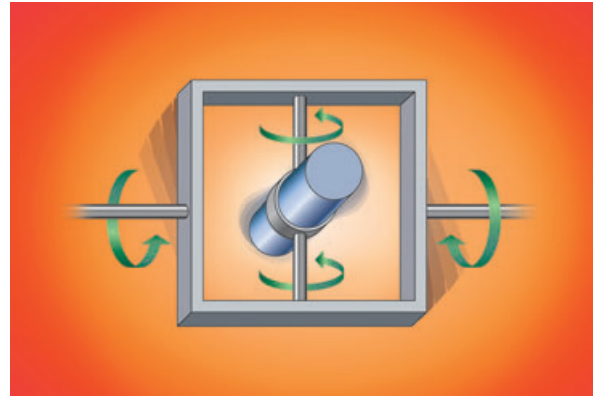

## SATISFIED CUSTOMERS WHO TRUST IN GUTBROD

AllessaChemie  
BASF Ludwigshafen  
BASF PharmaChemikalien  
BASF Rudolstadt  
BASF Schwarzheide  
Bayer CropScience  
Bayer HealthCare  
Bayer MaterialScience  
Bayer Schering  
Bayer Technology Services  
Biochemie  
Boehringer

Borealis  
Cabot  
Clariant  
DSM  
Dynamit Nobel  
DyStar  
Endress + Hauser  
Evonik  
Fluorchemie Dohna  
Haldor Topsoe  
Hoffmann-La Roche  
Ineos

Infineon  
Jungbunzlauer  
KataLeuna  
Kemira  
Krohne  
Lanxess  
Lenzing AG  
Merck  
Momentive  
OMV  
PCK  
Robert Bosch GmbH

Sachtleben Chemie  
Saltigo  
Sandoz  
Siegle + Epple  
Siltronic  
Solvay  
Stockhausen  
Tectrion  
Uhde  
Vinnolit  
Wacker Chemie

## PROCESS SEQUENCE

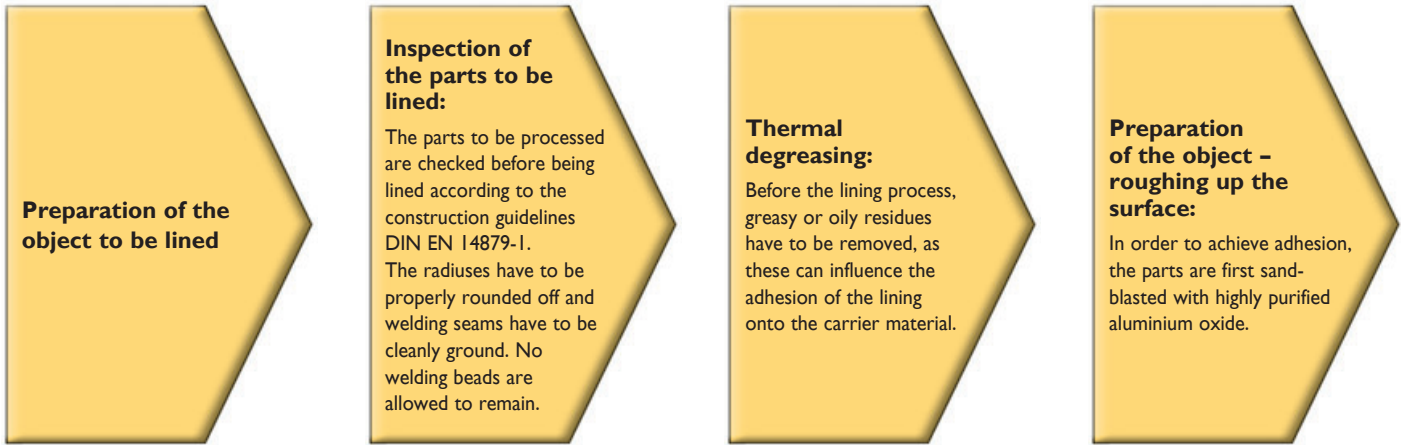

## DECISIVE ADVANTAGES OF ChemResist WITH

### Layer thicknesses up to 7 mm are possible

In conventional coating of components, the layer thickness is limited to approx. 1 mm. With the Gutbrod "ChemResist" system, wall thicknesses of up to 7 mm can be achieved.

### Seamless lining

Complex and difficult parts do not represent a problem for ChemResist. All surfaces of the workpiece are reliably lined with specific biaxial movements. The result is a perfect and homogeneous lining without seams and welding points.

### Reduced residual tension

As no pressure is required during the lining process, considerably less tension remains in the workpiece.

### Optimally adhering coating

ChemResist requires no adhesive, and no joints are produced either. The permanent and homogeneous lamination to the substrate means new and interesting perspectives in use under vacuum. For special applications in the high temperature range, a very thin primer may be used.



### Rotational sinter lining:

The components are fixed into a clamping device and filled with the appropriate material.

The lining temperature and rotational speed are individually set.

### Finishing:

Mechanical processing of the sealed surface.

### Inspection and quality control:

The components are inspected visually for appearance, layer thickness, pore impermeability and, if necessary, electrical conductivity, and an inspection certificate 3.1 according to DIN EN 10204 is issued. All test procedures are documented.

### Packaging and shipment

## THE MATERIALS ETFE, PFA AND PE

### Small lot sizes are also economical

It is also possible to complete small lot sizes economically using the technical rotation technology, even if there is a broad spectrum of complex forms and sizes.

### Cost-effective despite quality improvement

The steel construction can be planned considerably more cost-effectively. By reducing the flange connectors (and thereby the number of potential leakage points), quality can be increased considerably.

### Long-term safety

Homogeneous and permanent lamination to the substrate is achieved without the danger of collapsing with larger diameters. No safety risk through impact and longitudinal expansion, even at minus temperatures.

### Quality assurance in every dimension

ChemResist permits components to be lined regardless of the design up to a size of 2,600 mm in length, a diameter of up to 2,400 mm and a total weight of 2,200 kg, without rigid requirements on the construction itself.

The process sequence with entry and processing data is documented in detail.



## COMPARISON WITH CONVENTIONAL COATING AND LINING PROCESSES

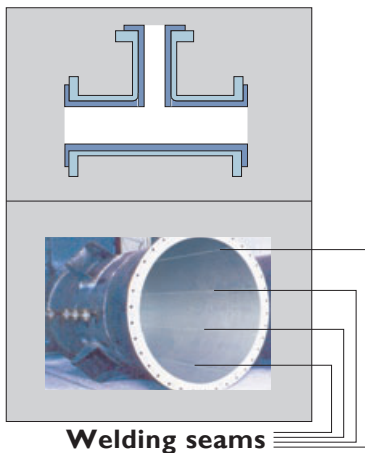

**Electrostatic spray coating**

ECTFE, PFA, FEP, ETFE

Primer

Metal

- Thickness: approx. 1 mm
- Primer principle
- Several heating phases required

**Loose lining**

PTFE, PFA

Welding seam

Metal

- Thickness: from 2 mm
- Ventilation holes are necessary
- Only simple forms are possible
- For complicated parts (tanks) loose linings have to be welded

**Conventional lining**

PTFE, PFA, ECTFE

Welding seam

Adhesive

Metal

- Reduced temperature resistance due to the use of adhesives
- Subsequent welding of joints is necessary

BEST POSSIBLE PROPERTIES – HIGHEST LEVEL OF COMPETENCY



Effect of Temperature on Tensile Strength

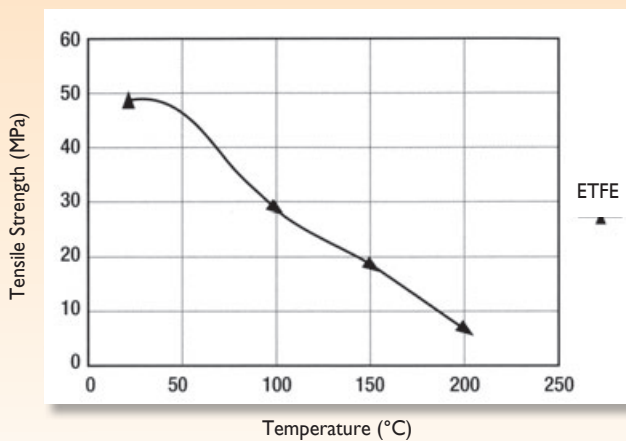

Effect of Temperature on Tensile Elongation

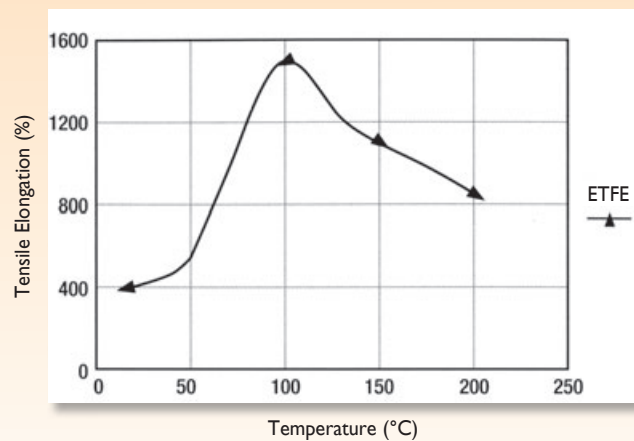

# PERFECT SOLUTIONS WITH ChemResist ROTATIONAL SINTER LINING

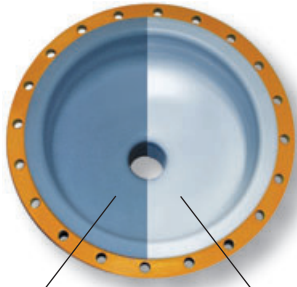

Standard ETFE

Ultra-pure ETFE;  
for pharmaceuticals,  
semi-conductor and  
special chemicals

**ETFE, PFA and PE Rotational sinter lining**

ETFE, PFA and PE
Metal

- Thickness: 2-7 mm
- Direct laminate with metal
- Only one heating phase
- Seamless lining

## **ChemResist** ROTATIONAL-LINING

**Seamless lining -  
No welding seams -  
No adhesives**



Effect of Temperature on Flexural Strength

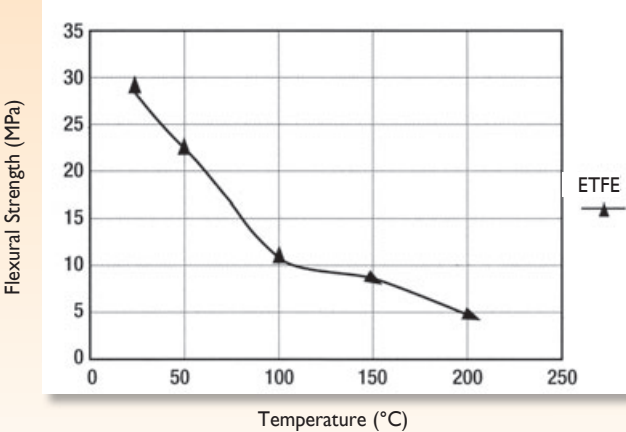

Effect of Temperature on Flexural Modulus

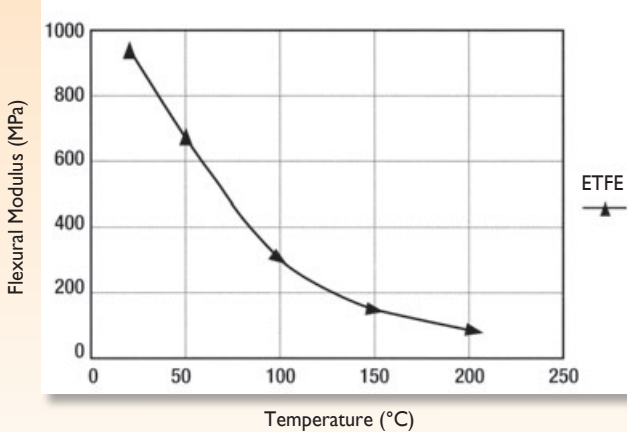

# ChemResist

ROTATIONAL-LINING

ETFE, PFA AND PE HAVE MANY EXCELLENT PROPERTIES

Reduction of costs  
Reduction of leakage points  
Reduction of weight

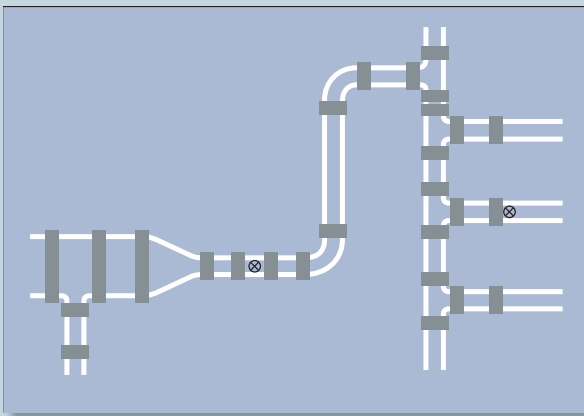

Conventional lining/ coating

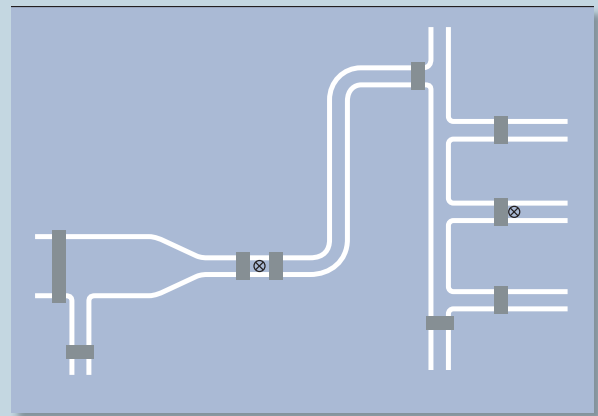

ChemResist Rotational Sinter Lining

- Exceptional, universal chemical resistance at high temperatures (ETFE, PFA)
- Purity
- No tension cracking
- Electrical conductivity (ETFE, PE)
- Repairable
- Solvent resistance
- Easy to clean, thanks to anti-adhesive surface (ETFE, PFA)
- FDA-conformity (ETFE, PFA, PE)
- Non flammable (ETFE, PFA)
- Resistant to cold
- More robust
- Approved according to the Code of Practice Air (ETFE, PFA)



## COMPETENT IN ALL ASPECTS ...

In order to survive in today's competitive environment we offer our customers not only perfect lining solutions, but also completely integrated concepts.

Optimal results emerge right from the start. You can count on our full-service consultancy competence from the very beginning.

# TYPICAL PROPERTIES OF FLUOURINATED PLASTICS

Items	Units	ETFE tetra- fluoroethylene- ethylene- copolymer	FEP tetrafluoroethylene- hexafluoropropylene- copolymer	PCTFE polychloro- trifluoro- ethylene	PVDF polyvinylidene- fluoride	PTFE polytetra- fluoro- ethylene	ASTM No		
Physical properties	Specific gravity	1.73 - 1.75	2.15 - 2.17	2.1 - 2.2	1.76 - 1.77	2.1 - 2.2	D792		
	Melting point	°C	265 - 270	285 - 295	212 - 217	170 - 185	327		
	Melt viscosity	poise (°C)	10 <sup>4</sup> - 10 <sup>5</sup> (300 - 330)	10 <sup>4</sup> - 10 <sup>5</sup> (350 - 380)	3× 10 <sup>6</sup> - 2× 10 <sup>7</sup> (270 - 300)	3× 10 <sup>6</sup> - 2× 10 <sup>7</sup> (270 - 300)	10 <sup>4</sup> - 10 <sup>5</sup> (300 - 300)		
Mechanical properties	Tensile strength 23°C	kg/cm <sup>2</sup>	410 - 470	190 - 220	300 - 400	500 - 600	70 - 280	JIS K689	
	Yield strength 23°C	kg/cm <sup>2</sup>	190 - 220	130 - 150	400 - 450	400 - 600	120 - 160	JIS K689I	
	Elongation 23°C	%	420 - 440	250 - 330	80 - 250	200 - 300	225 - 600	JIS K689I	
	Tensile modulus	kg/cm <sup>2</sup>	5 - 8× 10 <sup>3</sup>	3.5× 10 <sup>3</sup>	10 - 20× 10 <sup>3</sup>	8 - 14× 10 <sup>3</sup>	4× 10 <sup>3</sup>	D638	
	Flexural modulus	kg/cm <sup>2</sup>	9 - 10× 10 <sup>3</sup>	6.7× 10 <sup>3</sup>	17.6× 10 <sup>3</sup>	14 - 18× 10 <sup>3</sup>	3.5 - 6.3× 10 <sup>3</sup>	D790	
	Izod impact strength	ft-lb/in notch	no break	no break	3.0	3.5 - 3.8	3.0	D256	
	Rockwell hardness		R-50	R-25	R-75 - 95	R-110	R-18	D785	
	Frictional coeff. (against stainl. steel)		0.20	0.20	0.18	0.21	0.09		
Thermal properties	Linear thermal expansion coeff.	°C <sup>-1</sup>	9.4× 10 <sup>-5</sup>	9× 10 <sup>-5</sup>	10× 10 <sup>-5</sup>	12 - 15× 10 <sup>-5</sup>	10× 10 <sup>-5</sup>	D696	
	Flammability		Incombustible	Incombustible	Incombustible	Self-extinguish	Incombustible	D635	
	Continuous Service temperature	°C	150	220	180	150	260		
Chemical properties	Chemical resistance		Excellent	Excellent	Good	Good	Excellent	D543	
	Water absorption 23°C	%	0.01>	0.01>	0.00	0.34 - 0.04	0.01>	D570	
	Permeation (O <sub>2</sub> )	cc.mil/ 100 in <sup>2</sup> 24 hr • atm	148	300 - 900	4 - 90	3.3 - 4.0	1050	DI434	
	(N <sub>2</sub> )		45	150 - 170	1.5 - 22	0.9 - 2.1	390	DI43	
Electrical properties	Volume specific resistance	ohm/cm	10 <sup>17</sup>	10 <sup>18</sup>	1.4× 10 <sup>17</sup>	2 - 6× 10 <sup>17</sup>	10 <sup>18</sup>	D257	
	Dielectric constant tangent 23°C		2.4 - 2.6	2.1	2.5 - 2.8	3 - 11	2.1	DI50	
	Dielectric loss tangent 23°C	60 H <sub>2</sub>		0.0001>	0.0003	0.015	0.05	0.0001>	D150
		10 <sup>3</sup> H <sub>2</sub>		0.0005	0.0002	0.023	0.018	0.0001>	D150
		10 <sup>6</sup> H <sub>2</sub>		0.0032	0.0007	0.012	0.16	0.0001>	D150
		10 <sup>9</sup> H <sub>2</sub>		0.01	0.0005	0.01	0.11	0.0004	D150
Breakdown voltage (short time)	KV/0.1 mm film		12	12	12 - 13	9	8 - 10	JIS K689I	
Arc resistance	sec		120	165<	300<	50 - 70	300<	D495	

## ... EVEN COMPLETE SOLUTIONS

Start talking to us already in the planning phase. We shall be pleased to provide complete solutions and will take over the responsibility for your steel construction, in collaboration with our competent and certified partners.

With our own jig manufacturing (mounting objects up to 2.2 tonnes), modern means of production and facilities we produce according to state-of-the-art technology standards. Our processes and proce-

dures are certified according to ISO 9001:2008. We shall also continue to invest in new means of production in the future.



# THE RUDOLF GUTBROD COMPANY: PIONEER OF SURFACE TECHNOLOGY

Rudolf Gutbrod GmbH in Swabian Dettingen/Erms continues to set new standards in innovative coating technology. The company is leading in Europe as a processor of fluorinated polymers.

The enterprise was founded in 1964 and is a pioneer in Germany in surface coating technology with fluoropolymers. It is also a licensee in Europe of well-known raw material manufacturers and is one of Europe's top addresses as far as functional coatings with non-stick effect, low friction, chemical protection and corrosion protection are concerned. State-of-the-art technology is ensured through continuous development work.

Raw material procurement is undertaken on a worldwide basis. International and permanent exchange of ideas will also ensure in the future that the highest possible quality will be maintained in solving the different requirements of our customers.

We act with awareness for the environment in all our activities and products. We pay attention to avoiding environmental pollution and to using resources responsibly.





Industrie Service

Choose certainty.  
Add value.

## Inspection/certification of the ChemResist® ETFE fluoroplastic lining system from Rudolf Gutbrod GmbH under application of thermal stress and vacuum

Customer: Rudolf Gutbrod GmbH, Im Schwöllbogen 10,  
72581 Dettingen/Erms, Germany

Order: Order dated 14 January 2011

Order number: 600 115 575

Subject of the inspection: Inspection of the ChemResist® ETFE lining,  
applied to a column section (DN = 1000 mm,  
height = 1000 mm) with two flat covers

Preparation of the column section before application of the lining: Column section thermally degreased at 430 °C,  
then sand-blasted with aluminium oxide

Inspection conditions: Column section temperature 150 °C;  
pressure 25 mbar absolute (external overpressure approx. 1 bar); stress period 125 hours (> 5 days)

Start of inspection: 21<sup>th</sup> January 2011

End of inspection: 26<sup>th</sup> January 2011

Evaluation: 1<sup>st</sup> February 2011

State of lining before inspection: Thickness on container 3.6 to 4.2 mm (Ø 4.1 mm);  
thickness on cover 3.6 to 4.7 mm (Ø 4.2 mm),  
thickness on base 3.8 to 4.3 mm (Ø 4.0 mm).

The lining was bubble-free and exhibited no signs of contamination or external influences.

The cover and base were sealed against the mechanically-processed flange using PTFE sealing tape (10 x 3.0 mm). The cover and base were each fastened with 28 screws, with a torque of 220 Nm applied to each screw.

Inspection run: Two thermal elements were attached to the container for measuring the container temperature (steel body) and ambient temperature, and were connected to measuring devices. A metal hose was connected to the vacuum pump and a digital manometer through a flange in the cover.

Date: 2011-02-01

Our reference:  
IS-ATA5-STG/Ernst

Document:  
Rudolf Gutbrod 600 115 575  
ETFE Auskleidung englisch.doc

Report No. 600 115 575

This document consists of  
2 Pages.  
Page 1 of 2

Excerpts from this document may only be reproduced and used for advertising purposes with the express written approval of TÜV SÜD Industrie Service GmbH.

The text results refer exclusively to the units under test.





After application of an absolute vacuum of 25 mbar, the entire container was placed in a convection oven. The screw connections were retightened after one hour. With applied vacuum, the column section was then heated to 150 °C in the convection oven. The column temperature was reached after 5 hours and then maintained at 150 °C.

Temperature measurement:	Two temperature data loggers – Testo 735-1 and 735-2 (new devices with factory calibration; accuracy $\pm 0.2$ K). A thermal element was inserted into each bore on the flange in order to measure the column section temperature.
Pressure measurement:	Membranovac DM 12 with D/2000 sensor (new device with factory calibration; measurement uncertainty 0.5% from measured value)
Duration of inspection:	The inspection conditions were maintained for 125 hours and recorded for documentation (column section temperature 150 °C; pressure 25 mbar absolute (external overpressure ca. 1 bar); stress period 125 hours (> 5 days)).
State of lining after inspection:	No changes were detected as compared to the new condition before the inspection. In particular, there were no bubbles, cracks or lining detachment, etc.

### Inspection results:

Under inspection conditions, the lining exhibited no changes as compared to the new condition.

As such, ChemResist® ETFE fluoroplastic lining meets the following requirements:

- Object temperature 150 °C
- Vacuum 25 mbar absolute
- Stress period of 5 days

**Chemical resistance against media was not a part of this inspection.**

Filderstadt, 1<sup>st</sup> February 2011

Authorised assessor

A handwritten signature in blue ink, appearing to read 'B. Ernst'.

Bernd Ernst



Region Baden-Württemberg  
Bereich Anlagentechnik  
Institut für Kunststoffe



**RUDOLF GUTBROD GmbH**

Im Schwöllbogen 10

72581 Dettingen/Erms

Germany

Tel. +49(0)71 23 - 97 35-0

Fax +49(0)71 23 - 97 35-30

[www.gutbrod-ptfe.de](http://www.gutbrod-ptfe.de)

[info@gutbrod-ptfe.de](mailto:info@gutbrod-ptfe.de)