

# Control Valves

## Series 3003

Valve 3-way diverting/mixing

### Technical data

Size (DN)	DN 15—50 (½" - 2")
Pressure rating	UNI/DIN PN16-100, ANSI 150-600#
Connections	Flanges UNI PN16-100; Flanges ANSI 150-600# Threaded G, NPT; Welded BW, SW; Clamp
Type sealing	Soft (Class VI), metallic (Class IV - V - VI)
Characteristic	Linear, equalpercentage (eqp%)
Action	Pneumatic with diaphragm (supply max 3 bar)
Temperature	-196 to +350 °C

### Description

The control valves serie 3003 are three way with function DIVERTING or MIXING. The body is manufactured from bar stock stainless steel or special alloys and is easily adapted to meet application requirements. Cryogenic, high temperature or bellows sealed designs are available and can be delivered with very short delivery times. All our control valves are delivered as tested units and ready for a long lasting, maintenance free operation.

### Options

- ⇒ High temperature extension (finned bonnet)
- ⇒ Extension (- 100°C)
- ⇒ Cryogenic extension (- 196 °C)
- ⇒ Bellows seal (double wall PN16, triple wall PN40)
- ⇒ Full stainless steel actuator for corrosive environment
- ⇒ Special alloys for body: Hastelloy, Duplex, Monel
- ⇒ Special rating PN160/250
- ⇒ Handwheel for emergency operation
- ⇒ Valve positioners
- ⇒ Limit switches
- ⇒ Position feedback
- ⇒ Airset
- ⇒ Electric linear actuators (230 V AC, 24 V AC/DC)
- ⇒ Hand operating (manual)
- ⇒ Pneumatic with piston actuator (service ON/OFF)

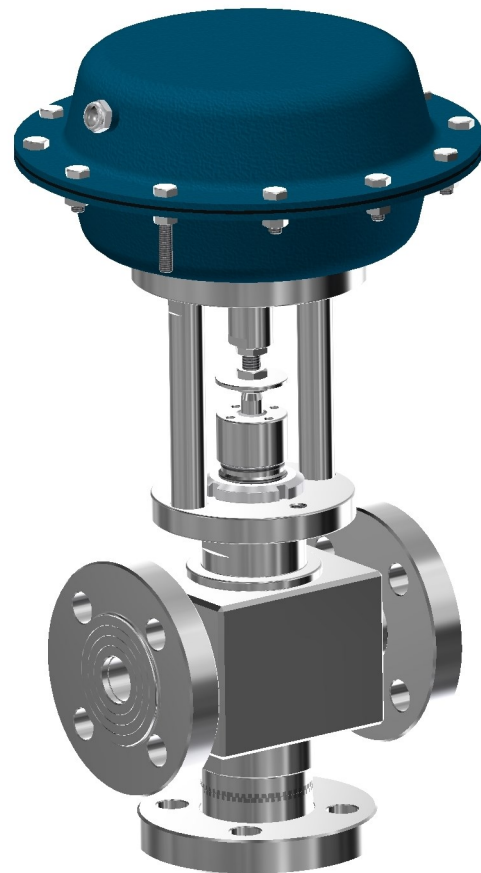

Flow rate coefficient (CV)						
DN	¼" (10)	½"(15)	¾"(20)	1" (25)	1½" (40)	2" (50)
CV	-	-	-	-	-	48
	-	-	-	-	28	28
	-	-	-	-	18	18
	-	-	-	12	12	12
	-	-	7	7	7	7
	-	4	4	4	4	4
	2,5	2,5	2,5	2,5	-	-

# Control Valves

## Series 3003

Valve 3-way diverting/mixing



RAM Universal Limited—Broughton Astley—Leicestershire—LE9 6TU

www.ramuniversal.co.uk

Tel.: +44 (0)1455 285428—Fax: +44 (0)1455 285404

Materials	
Valve body	316L
Trim (plug - seat)	316L / 17-4PH / Hastelloy / Duplex / Monel
Steam	316L / Hastelloy / Duplex / Monel
Packing	PTFE, PTFE+'OR' FPM, special
Body gasket	PTFE, SIL C4500, special
Acuator	FE (epoxy varnish), stainless steel
Yoke	Stainless steel

### Function overview

#### Diverting serie 3003D

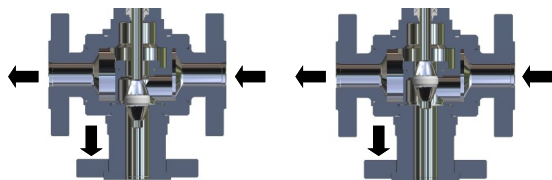

Normally open straight way

Normally open square way

#### Mixing serie 3003M

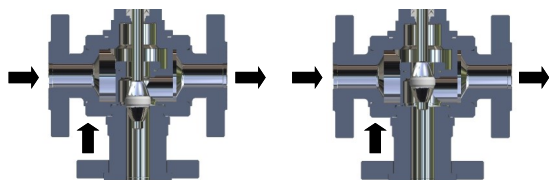

Normally open straight way

Normally open square way

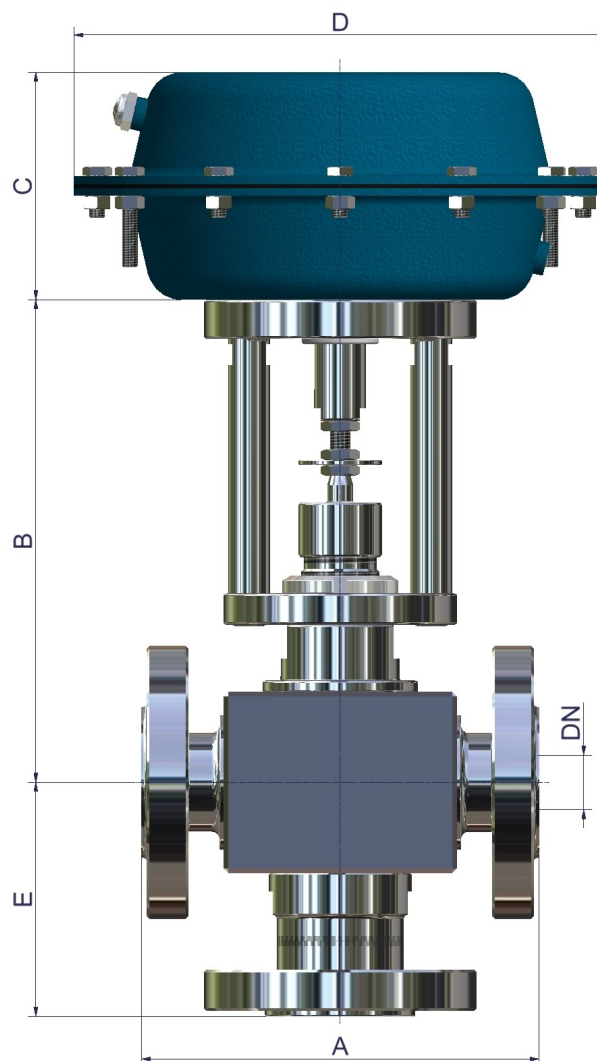

Dimensions Series 3003 <b>A</b> = face-to-face (mm) <b>E</b> = center-to-face (mm)								
A - E Flanged valves						A - E Threaded / welding valves		
DN	DIN PN		ANSI CLASS			DN	G / NPT Female	BW / SW
	16-40	63-100	150	300	600			
15	130 - 70	210 - 110	178 - 110	190 - 110	203 - 110	¼" - ½"	112 - 56	124 - 65
20	150 - 90	230 - 130	181 - 130	194 - 130	206 - 130	¾"	142 - 71	145 - 85
25	160 - 90	230 - 130	184 - 130	197 - 130	210 - 130	1"	142 - 71	155 - 85
40	200 - **	260 - **	222 - **	235 - **	251 - **	1 ½"	190 - **	194 - **
50	230 - **	300 - **	254 - **	267 - **	286 - **	2"	190 - **	224 - **

\*\* on request

# Control Valves

## Series 3003

Valve 3-way diverting/mixing

### End connections



Flanges UNI/DIN - ANSI

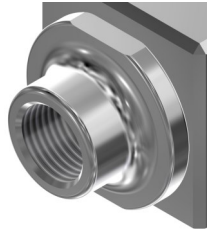

Threaded GAS - NPT

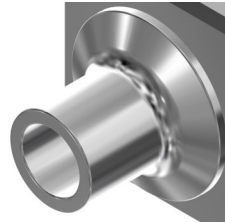

Welded BW

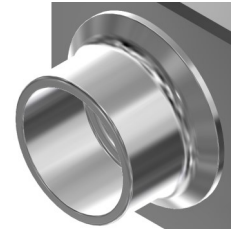

Welded SW

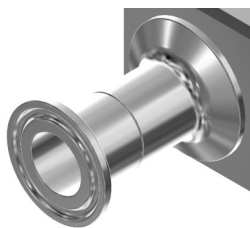

Clamp ISO

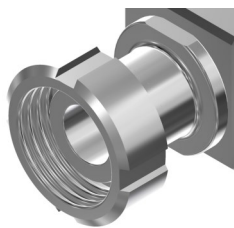

DIN 11851 (male)

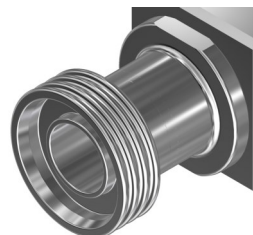

DIN 11851 (female)

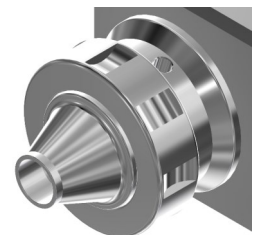

Special (on request)

### Bonnet specifications (temperatures limit employment)

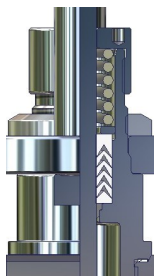

Standars (-30°C / +250 °C)

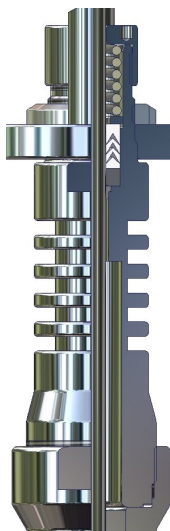

Finned (-30°C / +350 °C)



Bellows (-100°C / +250 °C)

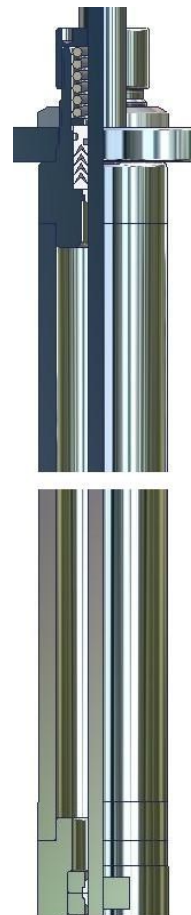

Cryogenic (-196°C / +180 °C)

# Control Valves

## Series 3003

Valve 3-way diverting/mixing



RAM Universal Limited—Broughton Astley—Leicestershire—LE9 6TU

www.ramuniversal.co.uk

Tel.: +44 (0)1455 285428—Fax: +44 (0)1455 285404

Dimensions Series 3003 (mm)						
B at different bonnet designs						
DN		Standard	-100 °C (extension)	-200 °C (cryogenic)	High Temp. (finned)	Bellows
15	¼" - ½"	180	305	660	305	300
20	¾"	190	310	665	310	305
25	1"	190	310	665	310	305
40	1 ½"	220	on request	on request	on request	405
50	2"	220	on request	on request	on request	405

Weight Series 3003 (kg) flanged valves (without actuator)									
DN	Weight with standard bonnet					Extra weight with bonnet extension			
	PN16-40	PN63-100	ANSI 150	ANSI 300	ANSI 600	-100 °C	-200 °C	High Temp.	Bellows
15	6	8,5	6	6,5	8	+ 1	+ 3	+ 1	+ 1,5
20	9,5	12,5	9,5	9,5	12,5	+ 1	+ 3	+ 1	+ 1,5
25	11,5	13,5	11	11,5	13,5	+ 1	+ 3	+ 1	+ 1,5
40	19,5	on request	on request	on request	on request	on request	on request	on request	+ 3
50	23	on request	on request	on request	on request	on request	on request	on request	+ 3

Weight Series 3003 (kg) threaded, welded valves					
DN	Weight with standard bonnet (without actuator)	Extra weight with bonnet extension			
		-100 °C	-200 °C	High Temp.	Bellows
¼" - ½"	4,0	+ 1	+ 3	+ 1	+ 1,5
¾"	6,0	+ 1	+ 3	+ 1	+ 1,5
1"	6,5	+ 1	+ 3	+ 1	+ 1,5
1 ½"	13	on request	on request	on request	+ 3
2"	14,5	on request	on request	on request	+ 3

Dimensions (mm) and weight (kg) Actuators				
Actuator	C	D	Air connection	Weight (kg)
S-200	90	205	1/8" GAS FF	2,5
S-275	100	275	1/4" GAS FF	6
S-340	135	340	1/4" GAS FF	13
S-430	140	430	1/4" GAS FF	17